

DET NR.		CNT		NAME			DIMENSION	NOTE	
CONSTR.	DRAWN	COPIED	CHECKED	STAND.	OK	SCALE	REPLACE	REPLACED BY	
MS						1:2			
				ICOM cable RRC-1258 to ICOM IC-E2820 Radio end			DATE		
							091005		
							DRAWING NR		
							1258 Cable I6 1(1)		

## RRC-1258

8-pol RJ 45 Con

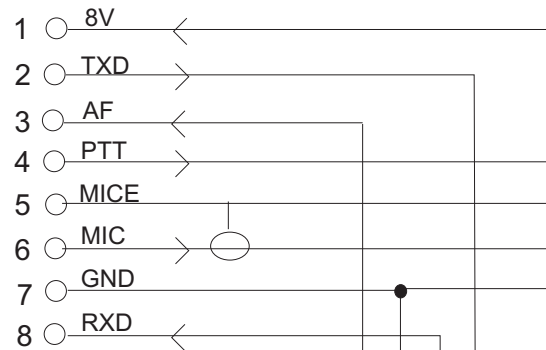
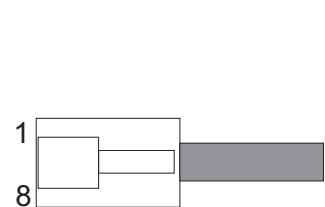

## Mic Inp IC-E2820

8-pol RJ 45 Con

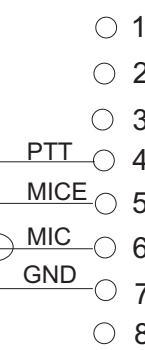
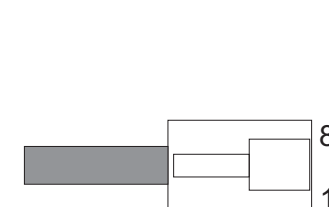

## Control Inp IC-E2820

4/6 pol Modular Con

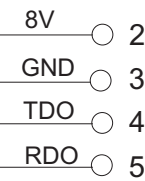
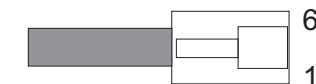

## Speaker Output

3,5 mm Mini stereo (male)

