

DET NR.		CNT		NAME			DIMENSION	NOTE	
CONSTR.	DRAWN	COPIED	CHECKED	STAND.	OK	SCALE	REPLACE	REPLACED BY	
MS						1:2			
							Kenwood cable RRC-1258 -> TS-2000 Radio RC-2000 Panel		DATE
									090901
							DRAWING NR		1258 Cable K9 1(1)

RRC-1258

8-pol RJ 45 Con

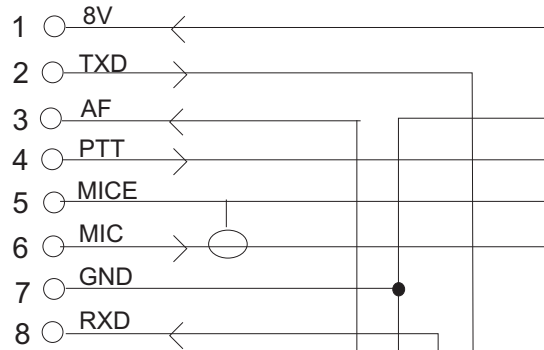
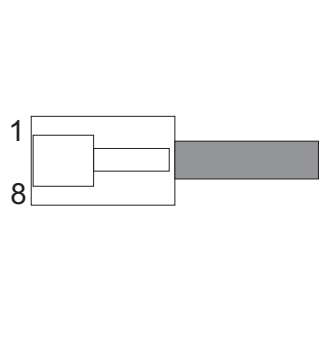

Mic TS-2000

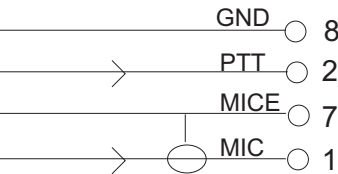

PANEL Inp TS-2000

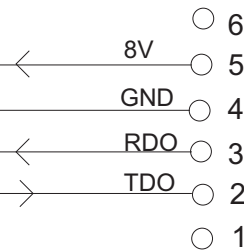

SPEAKER



8-pol Circular

Front panel view

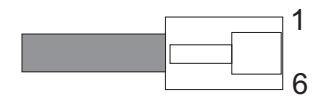
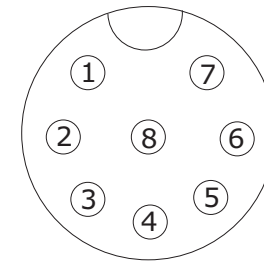

Attention!
Kenwood
numbering is
inverted

3,5 mm stereo plug

